



Quality is Behind the Diamond



Product Catalog

WHERE TO USE

















Amerex manufactures an extensive variety of hand portable and wheeled fire extinguishers, both “compliance” (code required) and “specialty” types. “Specialty” type extinguishers are intended for use on particular types of hazards, so careful attention should be made to locating them in close proximity to the specific hazard they are meant to protect. It is natural for a person to use the extinguisher located nearest to a fire. The most current issue of NFPA-10 should be consulted for minimum recommended fire extinguisher types, placement and travel distances. Your local Amerex Fire Equipment Distributor is professionally equipped to help you evaluate and implement these recommendations.

All “Picture Symbols” are detailed below and should be reviewed with all who might be expected to use a fire extinguisher. Everyone should be familiar with these picture symbols which identify the types of fires on which they may be used. The International sign system **diagonal red slash** indicates a potential danger if the extinguisher is used on that particular type of fire.

TYPES OF FIRES

- CLASS A** **ORDINARY COMBUSTIBLES:**
wood, paper, rubber,
fabrics and many plastics 
- CLASS B** **FLAMMABLE LIQUIDS & GASES:**
gasoline, oils, paint,
lacquer and tar 
- CLASS C** **FIRES INVOLVING
LIVE ELECTRICAL
EQUIPMENT** 
- CLASS D** **COMBUSTIBLE METALS
OR
COMBUSTIBLE METAL ALLOYS
(NO picture symbol)** 
- CLASS K** **FIRES IN COOKING APPLIANCES
THAT INVOLVE COMBUSTIBLE
COOKING MEDIA
vegetable or animal oils and fats** 

TYPES OF EXTINGUISHERS

- CLASS A**   
- CLASS A:B**   
- CLASS A:B:C**   
- CLASS A:C**  
- CLASS B:C**  
- CLASS D** 
- CLASS A:K**  

HOW TO USE

All Amerex extinguishers are furnished with a detailed “Owners Manual” containing valuable information. The manual contains information on the installation, use and maintenance of the extinguisher. The extinguisher nameplate (label) contains specific information on “HOW TO USE” the particular extinguisher. The label instructions vary slightly according to type and size. All potential operators should be totally familiar with the instructions on any extinguisher they might be required to use.

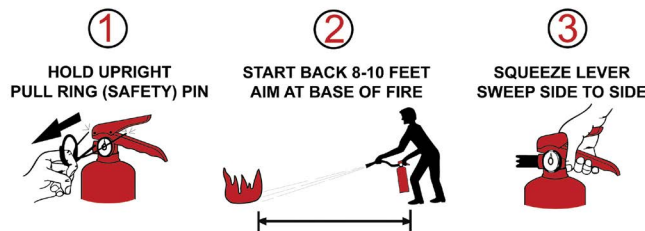

ALL AMEREX FIRE EXTINGUISHERS COMPLY WITH THE RECOMMENDATIONS OF THE NATIONAL FIRE PROTECTION ASSOCIATION AND ARE TESTED AND RATED BY UNDERWRITERS LABORATORIES OR FM GLOBAL TO ANSI / UL STANDARDS. ALL EXTINGUISHER NAMEPLATES CONTAIN THE NECESSARY HMIS INFORMATION TO COMPLY WITH NATIONAL AND LOCAL OSHA REQUIREMENTS.



Amerex Corporation

RUGGED

- 5 Year Manufacturer's Warranty
- Stored Pressure Design
- Polished Stainless Steel Cylinders -
USCG Models have Durable High Gloss Polyester Powder Paint Coating
- All Metal Valve Construction
- Exclusive crevice free, butt welded cylinders
- Temperature Range +40°F to 120°F

CLEAN

- Leaves no powder residue

USER FRIENDLY

- Maximum visibility during discharge
- Large Loop Stainless Steel Pull Pin
- Bar Coded and Bi-lingual Labels



Model 240



Model 254

Model 250



Model 250CG



AVAILABLE IN A 33 GAL. AR-AFFF ATC WHEELED EXTINGUISHER

Model 240 utilizes the cooling, soaking and penetrating effect of a 45-55 ft. stream of WATER. The 55 sec. discharge time makes it very effective for inexperienced operators for use on Class A fires.

Model 254 AFFF ATC FOAM unique 6 liter size fills many requirements for a lighter, more compact Class A:B extinguisher. Easy and effective application with the spray nozzle. The Alcohol Tolerant Concentrate fire fighting agent is effective on fires in a wide variety of Class B materials such as alcohols, polar solvents, hydrocarbons and combinations such as gasohol. Apply to a non-ignited Class B liquid spill and it will seal the surface preventing ignition, minimizing the chance of serious fire. Ideal for emergency first response vehicles.

Model 250 AFFF ATC FOAM Class A:B extinguisher. Easy and effective application with air aspirated nozzle. The Alcohol Tolerant Concentrate fire fighting agent is effective on fires in a wide variety of Class B materials such as alcohols, polar solvents, hydrocarbons and combinations such as gasohol. Apply to a non-ignited Class B liquid spill and it will seal the surface minimizing the chance of serious fire. Ideal for emergency first response vehicles.

The Model 240 may be freeze protected to -40°F by adding a Model 506B Anti-Freeze charge

AGENT TYPE	WATER		AFFF ATC FOAM	
	HOSE & NOZZLE	HOSE & SPRAY NOZZLE	HOSE & AIR ASPIRATED NOZZLE	HOSE & AIR ASPIRATED NOZZLE
DESIGN				
MODEL NUMBER	240	254	250 / 250CG	
UL & ULC RATING	2A	2A:10B	3A:20B	
CAPACITY	2.5 GAL	6 LITER	2.5 GAL	
SHIPPING WT. (LBS. EMPTY)	7.5	7.5	11	
HEIGHT (IN.)	24.5	19	24.5	
WIDTH (IN.)	9	8	9	
DEPTH (IN.)	7	7	7	
RANGE (INITIAL- FT)	45-55	10-12	10-12	
DISCHARGE TIME (SEC.)	55	30	55	
INCLUDED BRACKET	WALL	WALL	WALL	

Manufactured and Tested to ANSI/UL Standards
Complies with NFPA 10 Standard
ISO-9001 / ISO-14001 Certified
UL LISTED

CONFORMS TO TEST STANDARDS:

WATER: CAN/ULC-S507 - ANSI/UL626 & CAN/ULC-S508 - ANSI/UL711

FOAM: CAN/ULC-S554 - ANSI/UL8 & CAN/ULC-S508 - ANSI/UL711



Amerex Corporation

RUGGED

- 5 Year Manufacturer's Warranty
- Stored Pressure Design
- Polished Stainless Steel Cylinders - USCG Models have Durable High Gloss Polyester Powder Paint Coating
- All Stainless Steel Valve Construction
- Exclusive Crevice Free, Butt Welded Cylinder
- Tested on Commercial Deep Fat Fryers to ANSI / UL 711 Test Protocol and Safe to Use on Energized Electrical Appliances
- Class 2A Rated to Meet Fire Code Occupancy Hazard Requirements
- Temperature Range +40°F to 120°F

USER FRIENDLY

- Factory Charged
- Large Loop Stainless Steel Pull Pin
- Swivel Connection on Hose Allows Nozzle to be Oriented for Proper Use
- Nozzle Grip Design with 45° Angle for Easy "Overhead" Application
- Agent Discharged as a Fine Mist Helps Prevent Grease Splash and Re-flash While Cooling the Appliance
- Precise Extinguishing Agent Application
- Bar Coded and Bi-lingual Labels

OPTION

- USCG Approved with Bracket Listed on UL Label



B260

B262



Coast Guard Approved

B260CG B262CG



MUST USE 810CG BRACKET

*(Sold Separately)

WET CHEMICAL extinguishers are the best restaurant kitchen appliance hand portable fire extinguishers you can purchase. Each model has been tested and approved for the Class K listing by UL specifically for restaurant kitchen hazards. They contain a special potassium acetate based agent. The recent trend to more efficient cooking appliances and use of vegetable based cooking oils dictates the use of a hand portable fire extinguisher with greater fire fighting capacity and cooling effect to combat these very hot and difficult fires. Available in two sizes - 6 liter or 2½ gal. - with attractive stainless steel cylinders and easy to use hose and spray application nozzle. The superior fire fighting capability of the Wet Chemical agent is placed exactly where you aim it with no dry chemical residue to clean up. The Models B260 and B262 are the ideal "KITCHEN USE" fire extinguishers. They supplement existing cooking equipment automatic system protection for an extra margin of safety.

Excellent for use on all cooking appliances including solid fuel charbroilers

AGENT TYPE	WET CHEMICAL			
DESIGN	HOSE & SPRAY NOZZLE			
MODEL NUMBER	B260	B262	B260CG	B262CG
UL & ULC RATING	2A-K		2A-K	
CAPACITY	6 LITER	2.5 GAL	6 LITER	2.5 GAL
SHIPPING WT. (LBS.)	22.5	33.5	22.5	33.5
HEIGHT (IN.)	19	24.5	19	24.5
WIDTH (IN.)	9	9	9	9
DEPTH (IN.)	7	7	7	7
RANGE (INITIAL- FT)	10-12	10-12	10-12	10-12
DISCHARGE TIME (SEC.)	53	107	53	107
INCLUDED BRACKET	WALL	WALL	WALL	WALL

Complies with NFPA 10 Standard
ISO-9001 and ISO-14001 Certified
UL LISTED

CONFORMS TO TEST STANDARDS:

CAN/ULC-S554 - ANSI/UL8 &
CAN/ULC-S508 - ANSI/UL711



Amerex Corporation

RUGGED

- 5 Year Manufacturer's Warranty
- Stored Pressure Design
- Stainless Steel Cylinders
- Durable High Gloss Polyester Powder Paint
- All Metal Valve Construction
- Exclusive Crevice Free, Butt Welded Cylinder
- Temperature Range +40°F to 120°F

MR CONDITIONAL

- Non-magnetic Construction Tested by an Independent Agency for use in MRI Facilities to 11.7 Tesla (including wall hanger bracket)

CLEAN

- Non-toxic - Causes no Respiratory Problems
- De-ionized Water Extinguishing Agent (sold separately)
- Sanitary White Paint Finish (easy to clean)
- No Powder Residue

USER FRIENDLY

- Wand Provides Greatest Operator Safety
- Large Loop Stainless Steel Pull Pin
- Maximum Visibility During Discharge
- No Electrical Conductivity Back to the Operator
- No Thermal or Static Shock
- Minimal Training - Simplest to use
- Most Economical Agent Available
- Bar Coded and Bi-lingual Labels

OPTION

- Polished Stainless Steel Cylinders



B270

B272



NON-MAGNETIC



MR CONDITIONAL
THIS EXTINGUISHER HAS BEEN TESTED TO OPERATE PROPERLY AND POSE NO SAFETY HAZARD IN AN MRI ENVIRONMENT ASSOCIATED WITH MR SYSTEMS OPERATING AT 11.7 TESLA OR LESS.

WATER MIST is the ultimate extinguisher for Class A fires and where a potential Class C (electrical) hazard exists. The fine spray from the unique misting nozzle provides safety from electrical shock, greatly enhances the cooling and soaking characteristics of the agent and reduces scattering of burning materials. The Amerex Water Mist extinguishers contain de-ionized water (sold separately) making them the best extinguishers for protection of hospital environments, telecommunication facilities and "clean room" manufacturing facilities. The Amerex Water Mist extinguishers are easy to use, maintain, and service.

Tested to 11.7 Tesla

AGENT TYPE	DE-IONIZED WATER	
	HOSE & WAND	
DESIGN	HOSE & WAND	
MODEL NUMBER	B270	B272
UL & ULC RATING	2A:C	2A:C
CAPACITY	1.75 GAL	2.5 GAL
SHIPPING WT. (LBS. EMPTY)	7	8
HEIGHT (IN.)	19	24.5
HEIGHT WITH HOSE AND WAND INSTALLED (IN.)	24.5	27.5
WIDTH (IN.)	11	11
DEPTH (IN.)	7	7
RANGE (INITIAL- FT)	10-12	10-12
DISCHARGE TIME (SEC.)	72	80
INCLUDED BRACKET	NM WALL	NM WALL

Manufactured and Tested to ANSI/UL Standards
Complies with NFPA 10 Standard
ISO-9001 / ISO-14001 Certified
UL LISTED

CONFORMS TO TEST STANDARDS:

CAN/ULC-S554 - ANSI/UL8 &
CAN/ULC-S508 - ANSI/UL711



Amerex Corporation

RUGGED

- 6 Year Manufacturer's Warranty
- Stored Pressure Design
- Dependable Drawn Steel Cylinders
- Durable High Gloss Polyester Powder Paint
- All Metal Valve Construction
- Temperature Range -40°F to 120°F

ENVIRONMENTALLY ACCEPTABLE

- EPA approved "Clean Agent" for Class A, B and C hazards
- Low GWP (Global Warming Potential)
- Low ODP (Ozone Depletion Potential)
- Short Atmospheric Lifetime

CLEAN

- Leaves No Residue

USER FRIENDLY

- Maximum Visibility During Discharge
- Large Loop Pull Pin
- No Electrical Conductivity Back to the Operator
- No Thermal or Static Shock
- Bar Coded and Bi-lingual Labels

OPTION

- 5 lb. (B386T), 11 lb. and 15 ½ lb. Extinguishers are USCG Approved with Bracket Listed on UL Label
- Chrome Cylinders (See Chart Below) Bar
- Coded and Bi-lingual Labels

Halotron™ I clean fire extinguishing agent discharges as a rapidly evaporating liquid, which is non-conductive, non-corrosive, and leaves behind no residue. Halotron™ I is the clean agent market leader with a history of successful real-world protection of valuable assets. From model scale aircraft to wide body commercial aircraft, from data centers to pharmaceutical and other industrial plants, the Halotron™ I agent has been used to extinguish the fire, limit damage and help reduce downtime that can be caused by other agents. The Halotron™ I clean agent has been determined to be the most environmentally beneficial halocarbon agent on the market today that meets wide performance standards. The primary raw material in the agent is HCFC-123, which has an outstanding profile of near-zero ozone depleting potential (0.0098, CFC-11=1.0) and a low global warming potential (77, 100 yr. CO2 time horizon). State of the art atmospheric modeling completed in 2009 describes the smaller environmental footprint than HFC-based agents available for portable extinguishers. Ideal applications for these extinguishers include: data centers, laboratories, manufacturing plants, general office areas, computer rooms, telecommunication facilities, clean rooms, control rooms, warehouses, military electronics, vehicles including classic autos, boats, engine compartments, aircraft ramps, onboard aircraft and in facilities that service aircraft and any facility where dry chemical extinguishers could cause unacceptable damage or contamination.

FAA Approved Models Available (See Chart Below)

AGENT TYPE	HALOTRON™ I					
	ANODIZED ALUMINUM				CHROMED BRASS	
DESIGN	NOZZLE				HOSE & NOZZLE	
MODEL NUMBER	A384T	B385TS	B386T	B394TS	397	398
UL & ULC RATING	1B:C	2B:C	5B:C	5B:C	1A:10B:C	2A:10B:C
CAPACITY (LBS.)	1.4	2.5	5	5.5	11	15.5
SHIPPING WT. (LBS.)	3.25	5.25	9.5	10	22.5	27.5
HEIGHT (IN.)	10	15.5	15.25	15	21.88	21.88
WIDTH (IN.)	3.5	6.38	5.75	5.13	9.25	9.25
DEPTH (IN.)	2.63	3	4.25	4.25	6	6
RANGE (INITIAL- FT)	6-8	6-10	9-15	9-15	9-15	12-18
DISCHARGE TIME (SEC.)	9	9	9	9	9	14
OPTIONAL CHROME CYLINDER	YES	YES	YES		YES	
MINIMUM CONFINED SPACE REQUIREMENTS (CU. FT.)	196	350	700	770	1540	2170
FAA APPROVED MODEL				YES	YES	YES
INCLUDED BRACKET	VEHICLE	VEHICLE	VEHICLE	AIRCRAFT	WALL	WALL



Aluminum Valve
A384T
B385TS
B386T



B394TS
FAA Model



Brass Valve
397
398



**AVAILABLE IN 65 / 150 LB.
WHEELED EXTINGUISHERS**

**Manufactured and Tested to ANSI/UL Standards
Complies with NFPA 10 Standard
ISO-9001/ ISO-14001 Certified
UL LISTED**

CONFORMS TO TEST STANDARDS:

CAN/ULC-S556 - ANSI/UL2129 &
CAN/ULC-S508 - ANSI/UL711



Amerex Corporation

RUGGED

- 1 Year Manufacturer's Warranty
- Stored Pressure Design
- Dependable Drawn Steel Cylinders
- Durable High Gloss Polyester Powder Paint
- All Metal Valve Construction
- Temperature Range -65°F to 120°F

CLEAN

- Leaves no residue
- Reclaimed Halon 1211 is Restored to Original Military Specification
- Uses All Recycled Gas in Accordance With The Montreal Protocol

USER FRIENDLY

- Maximum Visibility During Discharge
- Large Loop Pull Pin
- No Electrical Conductivity Back to the Operator
- No Thermal or Static Shock
- Bar Coded and Bi-lingual Labels

OPTION

- USCG Approved with Bracket Listed on UL Label (except model A344T)
- Chrome Cylinders (See Chart Below)



Aluminum Valve
A344T
C352TS
B355T



C354TS



Brass Valve
B369
B371
361



HALON 1211 is a liquified gas, pressurized with nitrogen, which discharges as a vapor causing no cold or static shock and no impairment of the operator's vision. This "CLEAN" agent quickly penetrates difficult to see and hard to reach areas and leaves no residue. It is recommended for protection of delicate, sensitive and expensive computers, electrical equipment, tapes and film, automotive and aircraft engines, laboratory chemicals and equipment.

Quality industrial grade hardware, "CLEAN" agent, light weight, good discharge range and excellent fire extinguishing ability.

Recycled gaseous agent certified to meet military specifications

AGENT TYPE	HALON 1211						
	ANODIZED ALUMINUM				CHROME PLATED BRASS		
VALVE TYPE	NOZZLE		HOSE	NOZZLE	HOSE		
DESIGN							
MODEL NUMBER	*A344T	* C352TS	* C354TS	B355T	B369	B371	361
UL RATING	2B:C	5B:C	5B:C	10B:C	10B:C	2A:40B:C	4A:80B:C
CAPACITY (LBS.)	1.25	2.5	3	5	9	13	17
SHIPPING WT. (LBS.)	2.75	5.5	6	9.75	16.75	22	36.25
HEIGHT (IN.)	10	14.38	14.38	15.25	16.25	20.25	24
WIDTH (IN.)	3.63	4.5	6	5.75	8.5	8.5	9.75
DEPTH (IN.)	2.63	3	3	4.25	5	5	7
RANGE (INITIAL- FT)	9-12	9-15	9-15	9-15	12-18	12-18	12-18
DISCHARGE TIME (SEC.)	10	10	12	10	9	14	22
OPTIONAL CHROME CYLINDER	YES	YES	YES	YES		YES	
MINIMUM SPACE REQUIREMENTS (CU. FT.)	156	312	375	624	1123	1622	2120
INCLUDED BRACKET	VEHICLE	AIRCRAFT	AIRCRAFT	VEHICLE	WALL	WALL	WALL

* SPECIAL VALVE DESIGN FOR AIRCRAFT INSTALLATIONS

Manufactured and Tested to
ANSI/UL Standards
Complies with NFPA 10 Standard
ISO-9001/ ISO-14001 Certified
UL LISTED

CONFORMS TO TEST STANDARDS:

UL-1093 - ANSI/UL711

HALON 1211



Amerex Corporation

RUGGED

- 5 Year Warranty
- All Metal Valve Construction
- Rust free aluminum cylinders
- Durable High Gloss Polyester Powder Paint
- Temperature Range -22°F to 120°F

USER FRIENDLY

- Meets Many Hospital Medical Equipment Requirements
- Large Loop Stainless Steel Pull Pin
- Model 322NM is Independently Tested and Approved for use in MRI Facilities to 11.7 Tesla
- Model 322NM has a Sanitary White Paint Finish (easy to clean)
- Bar Coded and Bi-lingual Labels

OPTION

- USCG Approved with Bracket Listed on UL Label



MODELS

332 331
322 330



AVAILABLE IN 50 / 100 lb. WHEELED EXTINGUISHERS



**Model 322NM
NON-MAGNETIC**



MR CONDITIONAL
THIS EXTINGUISHER HAS BEEN TESTED TO OPERATE PROPERLY AND POSE NO SAFETY HAZARD IN AN MRI ENVIRONMENT ASSOCIATED WITH MR SYSTEMS OPERATING AT 11.7 TESLA OR LESS.

CARBON DIOXIDE is discharged as a white cloud of “snow” which smothers a fire by eliminating oxygen. It is effective for Class B flammable liquids and is electrically non-conductive. Carbon Dioxide is a clean, non-contaminating, odorless gas.

Non-Magnetic model available (Model 322NM - Tested to 11.7 Tesla)

AGENT TYPE					
VALVE TYPE					
DESIGN	HOSE & HORN				
MODEL NUMBER	322	322NM	330	331	332
UL & ULC RATING	5B:C	5B:C	10B:C	10B:C	10B:C
CAPACITY (LBS.)	5	5	10	15	20
SHIPPING WT. (LBS.)	13.1	13.1	28.25	37.75	50.75
HEIGHT (IN.)	17.75	17.75	24	30	30
WIDTH (IN.)	8.25	8.25	12	12	13
DEPTH (IN.)	5.25	5.25	7	7	8
RANGE (INITIAL- FT)	3-8	3-8	3-8	3-8	3-8
DISCHARGE TIME (SEC.)	9	9	11	15	19
INCLUDED BRACKET	WALL	NM WALL	WALL	WALL	WALL

**Manufactured and Tested to ANSI/UL Standards
Complies with NFPA 10 Standard
ISO-9001 / ISO-14001 Certified
UL LISTED**

CONFORMS TO TEST STANDARDS:

CAN/ULC-S503 - ANSI/UL154 &
CAN/ULC-S508 - ANSI/UL711



Amerex Corporation

RUGGED

- 6 Year Warranty
- Stored Pressure Design
- Dependable Drawn Steel Cylinders
- Special corrosion resistant yellow
- Class D color coded paint finish
- All Metal Valve Construction
- Temperature Range -40°F to 120°F

USER FRIENDLY

- Unique “soft flow” extension applicator plus built in long range nozzle
- Large Loop Stainless Steel Pull Pin
- Bar Coded and Bi-lingual Labels



MODELS

- B570
- B571



CLASS D

The Amerex “soft flow” extension applicator is particularly suited for fighting Class D fires. It allows the operator to stand away from the extreme heat and toxic fumes caused by burning material. The easily controlled, even discharge provides a non-dispersing application of the agent. The extension applicator may be quickly detached to provide a straight stream of chemical where greater range is required.

MODEL B570 contains a special blended Sodium Chloride based dry powder extinguishing agent. Heat from the fire causes it to cake and form a crust excluding air and dissipating heat from burning metal. Metal fires involving magnesium, sodium, potassium and sodium-potassium alloys can be successfully extinguished with this extinguisher. There is data showing that zirconium, uranium, titanium, and powdered aluminum fires can be controlled and extinguished with this unique extinguisher.

Extinguishing Capacity

- Magnesium Chips: 4 ft² and/or 6 lbs. of metal
- Sodium or Potassium Spill: 5 ft² and/or 5 lbs. of metal
- Sodium or Potassium Spill Depth Over 1/2": 3 ft² and or 6 lbs. of metal
- Sodium Potassium Alloy Spill: 3 ft² and/or 2 lbs. of metal

Available in 150 lb. Wheeled

MODEL B571 contains a copper extinguishing agent specially developed by the U.S. Navy for fighting lithium and lithium alloy fires. The copper compound smothers the fire and provides an excellent heat sink for dissipating heat. Copper powder has been found to be superior to all other known fire extinguishing agents for lithium.

Extinguishing Capacity

4 ft² and/or 5 lbs. of lithium

Available in 250 lb. Wheeled

OPTIONAL MODEL 859 DOLLY CART PROVIDES FOR EASY TRANSPORT

For Combustible Metal Fires

AGENT TYPE	SODIUM CHLORIDE	COPPER
VALVE TYPE	CHROME PLATED BRASS	
DESIGN	HOSE & HORN OR WAND APPLICATOR	
MODEL NUMBER	B570	B571
CAPACITY (LBS.)	30	30
SHIPPING WT. (LBS.)	53	53
HEIGHT (IN.)	35	35
WIDTH (IN.)	13	13
DEPTH (IN.)	8	8
RANGE (INITIAL- FT)	3-6	3-6
DISCHARGE TIME (SEC.)	24	18
FM APPROVED	YES	YES
INCLUDED BRACKET	WALL	WALL

**Manufactured and Tested to ANSI/UL Standards
Complies with NFPA 10 Standard
ISO-9001 / ISO-14001 Certified
FM APPROVED**

CONFORMS TO TEST STANDARDS:

CAN/ULC-S504 - ANSI/UL299 &
CAN/ULC-S508 - ANSI/UL711



Amerex Corporation

RUGGED

- 6 Year Warranty
- Stored Pressure Design
- Dependable Drawn Steel Cylinders
- Durable High Gloss Polyester Powder Paint
- All Metal Valve Construction

Brass Valve - Heavy Duty

- Chrome Plated Brass Valve Body
- Stainless Steel Handle & Lever

Aluminum Valve - Light to Medium Duty

- Anodized Aluminum Valve Body
- Anodized Aluminum Handle & Lever
- Temperature Range -65°F to 120°F

USER FRIENDLY

- Easy and Economical to Maintain and Service
- Large Loop Pull Pin
- Bar Coded and Bi-lingual Labels

OPTION

- USCG Approved with Bracket Listed on UL Label
- Chrome Cylinders (See Chart Below)



Aluminum Valve
B417/T
B500/T
B402/T
B443
B456
A411



Brass Valve
B424
B461
B441
423



**AVAILABLE IN WHEELED
EXTINGUISHERS**

ABC or Multi-Purpose extinguishers utilize a specially fluidized and siliconized mono ammonium phosphate dry chemical. It chemically insulates Class A fires by melting at approximately 350°F and coats surface to which it is applied. It smothers and breaks the chain reaction of Class B fires and will not conduct electricity back to the operator.

Largest selection of size and extinguisher options available

AGENT TYPE	ABC DRY CHEMICAL									
VALVE TYPE	ANODIZED ALUMINUM						CHROME PLATED BRASS			
DESIGN	NOZZLE	HOSE & NOZZLE				HOSE & NOZZLE				
MODEL NUMBER	B417/B417T	B500/B500T	B402/B402T	B443	B456	A411	B424	B461	B441	423
UL & ULC RATING	1A:10B:C	2A:10B:C	3A:40B:C	3A:40B:C	4A:80B:C	10A:120B:C	2A:10B:C	3A:40B:C	4A:80B:C	10A:120B:C
CAPACITY (LBS.)	2.5	5	5	6	10	20	5	6	10	20
SHIPPING WT. (LBS.)	5.25/5.5	9.25/9.5	9.25/9.5	12.75	18	38	10.5	14	19.5	39
HEIGHT (IN.)	15.5	15.25	15.25	16	20	24	15.5	16.25	20.5	24
WIDTH (IN.)	5.75	7.25	7.25	7.75	7.75	10.25	8	8.5	8.75	10.25
DEPTH (IN.)	3	4.25	4.25	5	5	7	4.25	5	5	7
RANGE (INITIAL- FT)	9-15	12-18	12-18	15-21	15-21	15-21	12-18	15-21	15-21	15-21
DISCHARGE TIME (SEC.)	10	14	14	14.5	20	30	14	14	20	30
OPTIONAL CHROME CYLINDER	YES	YES	YES		YES			YES	YES	
INCLUDED BRACKET	WALL/VEHICLE			WALL			WALL			

Manufactured and Tested to ANSI/UL Standards
Complies with NFPA 10 Standard
ISO-9001 / ISO-14001 Certified
UL LISTED

CONFORMS TO TEST STANDARDS:

CAN/ULC-S504 - ANSI/UL299 &
CAN/ULC-S508 - ANSI/UL711



Amerex Corporation

RUGGED

- 6 Year Warranty
- Stored Pressure Design
- Dependable Drawn Steel Cylinders
- Durable High Gloss Polyester Powder Paint
- All Metal Valve Construction

Brass Valve - Heavy Duty

- Chrome Plated Brass Valve Body
- Stainless Steel Handle & Lever

Aluminum Valve - Light to Medium Duty

- Anodized Aluminum Valve Body
- Anodized Aluminum Handle & Lever

- Temperature Range -65°F to 120°F

USER FRIENDLY

- Easy and Economical to Maintain and Service
- Large Loop Pull Pin
- Bar Coded and Bi-lingual Labels

OPTION

- USCG Approved with Bracket Listed on UL Label
- Chrome Cylinders (See Chart Below)



Aluminum Valve
 A620T
 B403/T
 B409T
 B453/T
 B457
 A412



Brass Valve
 B462
 B447
 408



AVAILABLE IN WHEELED
 EXTINGUISHERS

REGULAR extinguishers contain a siliconized sodium bicarbonate based dry chemical with free flowing and non-caking additives. Economical Class B & C protection with lower initial cost and recharging. This chemical smothers fires in flammable liquids and pressurized gases and will not conduct electricity back to the operator.

Largest selection of size and extinguisher options available

AGENT TYPE	REGULAR DRY CHEMICAL								
	ANODIZED ALUMINUM					CHROME PLATED BRASS			
VALVE TYPE	NOZZLE				HOSE & NOZZLE				
DESIGN									
MODEL NUMBER	A620T	B403/B403T	B409T	B453/B453T	B457	A412	B462	B447	408
UL & ULC RATING	2B:C	10B:C	10B:C	40B:C	60B:C	120B:C	40B:C	60B:C	120B:C
CAPACITY (LBS.)	1	2.5	5	5.5	10	20	6	10	20
SHIPPING WT. (LBS.)	2.5	5.5	9.25	9.75	18	38	14	19.5	39
HEIGHT (IN.)	10	15.5	15.25	15.25	20	24	16.25	20.25	24
WIDTH (IN.)	3.5	5.75	5.5	7.25	7.75	10.25	8.5	8.75	10.25
DEPTH (IN.)	2.63	3	4.25	4.25	5	7	5	5	7
RANGE (INITIAL- FT)	5-8	9-15	12-18	12-18	15-21	15-21	15-21	15-21	15-21
DISCHARGE TIME (SEC.)	10	10	10	14	18	28	14	18	28
OPTIONAL CHROME CYLINDER	YES	YES	YES	YES	YES				
INCLUDED BRACKET	VEHICLE	WALL/VEHICLE	VEHICLE	WALL/VEHICLE	WALL				

Manufactured and Tested to ANSI/UL Standards
 Complies with NFPA 10 Standard
 ISO-9001 / ISO-14001 Certified
UL LISTED

CONFORMS TO TEST STANDARDS:

CAN/ULC-S504 - ANSI/UL299 &
 CAN/ULC-S508 - ANSI/UL711

REGULAR DRY CHEMICAL



Amerex Corporation

RUGGED

- 6 Year Warranty
- Stored Pressure Design
- Dependable Drawn Steel Cylinders
- Durable High Gloss Polyester Powder Paint
- All Metal Valve Construction

Brass Valve - Heavy Duty

- Chrome Plated Brass Valve Body
- Stainless Steel Handle & Lever

Aluminum Valve - Light to Medium Duty

- Anodized Aluminum Valve Body
- Anodized Aluminum Handle & Lever
- Temperature Range -65°F to 120°F

USER FRIENDLY

- Easy and Economical to Maintain and Service
- Large Loop Pull Pin
- Bar Coded and Bi-lingual Labels

OPTION

- USCG Approved with Bracket Listed on UL Label
- Chrome Cylinders (See Chart Below)



Aluminum Valve
B410T
B479/T
A413



Brass Valve
B460
415



AVAILABLE IN WHEELED
EXTINGUISHERS

PURPLE K extinguishers contain specially fluidized and siliconized potassium bicarbonate dry chemical which is particularly effective on Class B flammable liquids and pressurized gases. It is electrically non-conductive. Purple K has been the choice of oil, gas, chemical and utilities industries as the preferred fire fighting agent.

Largest selection of size and extinguisher options available

AGENT TYPE	PURPLE K DRY CHEMICAL				
		ANODIZED ALUMINUM		CHROME PLATED BRASS	
VALVE TYPE	NOZZLE	HOSE & NOZZLE			
DESIGN					
MODEL NUMBER	B410T	B479/B479T	A413	B460	415
UL & ULC RATING	10B:C	30B:C	120B:C	80B:C	120B:C
CAPACITY (LBS.)	2.5	5	20	10	20
SHIPPING WT. (LBS.)	5.5	9.5	38	19.5	39
HEIGHT (IN.)	15.5	15.25	24	20.5	24
WIDTH (IN.)	5.75	7.25	10.25	8.75	10.25
DEPTH (IN.)	3	4.25	7	5	7
RANGE (INITIAL- FT)	9-15	12-18	15-21	15-21	15-21
DISCHARGE TIME (SEC.)	10	12	28	22	28
OPTIONAL CHROME CYLINDER	YES	YES		YES	
INCLUDED BRACKET	VEHICLE	WALL/VEHICLE		WALL	

Manufactured and Tested to ANSI/UL Standards
Complies with NFPA 10 Standard
ISO-9001 / ISO-14001 Certified
UL LISTED

CONFORMS TO TEST STANDARDS:

CAN/ULC-S504 - ANSI/UL299 &
CAN/ULC-S508 - ANSI/UL711



Amerex Corporation

HIGH PERFORMANCE
Dry Chemical

RUGGED

- 12 Year Warranty
- Hot Dip Galvanized Drawn Steel Cylinders
- High Gloss Polyester Powder Paint (Best corrosion protection available)
- All Metal Valve Construction
- Gauge Guards - Chrome Plated Brass
- Protective Rubber Foot Rings
- Superior Range (Vertical & Horizontal)
- High (240 PSI) Operating Pressure
- Temperature Range -65°F to 120°F

CHOICE OF CHEMICALS:

ABC Multi Purpose, Regular, Purple K

SELECT FAST FLOW FOR:

- High Flow Rate
- Fast Discharge
- Quicker Knockdown
- More Operator Protection

SELECT COMPLIANCE FLOW FOR:

- Long Range
- Highest UL Ratings

USER FRIENDLY

- Wide Grip Allows Clearance for Gloved Hand
- Large Loop Stainless Steel Pull Pin
- Bar Coded and Bi-lingual Labels

OPTION

- USCG Approved with Bracket Listed on UL Label
- Hot dip galvanized USCG brackets available



Fast Flow

- 594
- 581
- 567
- 582
- 568
- 595
- 580
- 584
- 569

Compliance Flow

- 592
- 564
- 589
- 599
- 566
- 591



AVAILABLE IN 125 AND 250 LB. WHEELED EXTINGUISHERS

HIGH PERFORMANCE extinguishers are the ultimate choice in fire extinguishers for high hazard, frequent use and extreme environment applications. Economical - less initial cost, lower maintenance costs and greater reliability than cartridge operated extinguishers.

Lower initial cost and lower costs to maintain

AGENT TYPE	ABC DRY CHEMICAL			REGULAR DRY CHEMICAL			PURPLE K DRY CHEMICAL			ABC DRY CHEMICAL			PURPLE K DRY CHEMICAL		
PERFORMANCE	FAST FLOW						COMPLIANCE FLOW								
VALVE TYPE	CHROME PLATED BRASS WITH GAUGE GUARD														
DESIGN	HOSE & NOZZLE														
MODEL NUMBER	594	581	567	582	568	595	580	584	569	592	564	589	599	566	591
UL & ULC RATING	2A:40B:C	4A:40B:C	4A:40B:C	40B:C	40B:C	40B:C	40B:C	20B:C	40B:C	4A:80B:C	10A:120B:C	10A:160B:C	80B:C	120B:C	160B:C
CAPACITY (LBS./KG)	13.2/6	20/9	30/13.6	20/9	30/13.6	13.2/6	20/9	20/9	30/13.6	13.2/6	20/9	30/13.6	13.2/6	20/9	30/13.6
SHIPPING WT. (LBS.)	31	43	58	43	58	31	43	43	58	31	43	58	31	43	58
HEIGHT (IN.)	17.5	24.75	26.5	24.75	26.5	17.5	24.75	24.75	26.5	17.5	24.75	26.5	17.5	24.75	26.5
WIDTH (IN.)	10.5	10.5	11	10.5	11	10.5	10.5	10.5	11	10.5	10.5	11	10.5	10.5	11
DEPTH (IN.)	7	7	8	7	8	7	7	7	8	7	7	8	7	7	8
RANGE (INITIAL- FT)	40-50			40-50			40-50			40-50			40-50		
DISCHARGE TIME (SEC.)	15	18	21	15	17	15	15	10	16	22	30	34	22	29	34
AVERAGE DISCHARGE RATE (LBS./SEC.)	.94	1.20	1.60	1.40	1.76	.94	1.44	2.00	1.88	.59	.65	.95	.61	.67	.81
INCLUDED BRACKET	WALL			WALL			WALL			WALL			WALL		

Manufactured and Tested to ANSI/UL Standards
Complies with NFPA 10 Standard
ISO-9001 / ISO-14001 Certified
UL LISTED

CONFORMS TO TEST STANDARDS:

CAN/ULC-S504 - ANSI/UL299 &
CAN/ULC-S508 - ANSI/UL711



Amerex Corporation

RUGGED

- 6 Year Warranty
- Stored Pressure Design
- Dependable Drawn Steel Cylinders
- Durable High Gloss Polyester Powder Paint
- All Metal Valve Construction

Brass Valve - Heavy Duty

Chrome Plated Brass Valve Body

Stainless Steel Handle & Lever

- Twice the Flow Rate of Standard Models
- Meets DOT Requirements
- Temperature Range -65°F to 120°F

USER FRIENDLY

- Easy and More Economical to Maintain and Service
- Large Loop Stainless Steel Pull Pin
- Bar Coded and Bi-lingual Labels

OPTION

- USCG Approved with Bracket Listed on UL Label
- ABC, Regular, or Purple K Chemical



MODELS (10 LB)

720
721
722

MODELS (20 LB)

760
761
762



HIGH FLOW portable fire extinguishers for applications where discharge rates exceeding one pound per second are required as specified in NFPA 10. These extinguishers utilize the same hardware and are manufactured to the same U.L. specifications as Amerex compliance rated products.

HIGH FLOW - Exceeds 1 lb. per second discharge rate

AGENT TYPE	ABC	ABC	REGULAR	REGULAR	PURPLE K	PURPLE K
MODEL NUMBER	720	760	721	761	722	762
CAPACITY (LBS.)	10	20	10	20	10	20
APPLICATION	HOSE & NOZZLE		HOSE & NOZZLE		HOSE & NOZZLE	
UL RATING	1A:20B:C	4A:60B:C	20B:C	60B:C	20B:C	60B:C
SHIPPING WEIGHT (LBS.)	19.5	39	19.5	39	19.5	39
DISCHARGE TIME (SEC.)	10	19	10	20	11	20
DISCHARGE RATE (LBS./SEC.)	1.22	1.14	1.15	1.13	1.15	1.08
DISCHARGE RANGE (FT.)	15-25	15-25	15-25	15-25	15-25	15-25
HEIGHT (IN.)	20½	24	20½	24	20½	24
WIDTH (IN.)	8¾	10¼	8¾	10¼	8¾	10¼
DEPTH (IN.)	5	7	5	7	5	7
TEMPERATURE RANGE (°F)	-65°F to 120°F					
INCLUDED BRACKET	WALL		WALL		WALL	

Manufactured and Tested to ANSI/UL Standards
Complies with NFPA 10 Standard
ISO-9001 / ISO-14001 Certified
UL LISTED

CONFORMS TO TEST STANDARDS:

CAN/ULC-S504 - ANSI/UL299 &
CAN/ULC-S508 - ANSI/UL711

WATER & FOAM CHARGES

Charge 502/504, 23 oz. bottle AFFF ATC – Model 250, 252 & 254

Note: Charge 502/504 is backwards compatible with previous models.

Charge 506B-2, two 2½ gal. bottles Loaded Stream/Anti-Freeze – Model 240

Charge 506B-55, 55 gal. drum Loaded Stream/Anti-Freeze - Model 240

Charge 534, 2-5/16 gal. pail AFFF ATC – Model 630 Wheeled



SPECIALTY FOAMS FOR FIREFIGHTING EQUIPMENT

3% AFFF Foam Concentrate - 5 Gallon Pails

Class “A” Foam Concentrate - 5 Gallon Pails

3 X 3 ATC Foam Concentrate - 5 Gallon Pails



WET CHEMICAL CHARGES

Charge 530-2, two 6 liter bottles – Model B260

Charge 660-2, two 2½ gal. bottles – Model B262



WATER MIST CHARGES

Charge 670-2, two 1¾ gal. bottles – Model B270NM

Charge 671-2, two 2½ gal. bottles – Model B272NM



HALOTRON™ I CHARGES

Charge 890, 35 lb. cylinder

Charge 891, 80 lb. cylinder

Charge 892, 200 lb. cylinder



CLASS D DRY POWDER CHARGES

Charge 543, 35 lb. pail Graphite (G-Plus)

Charge 532, 300 lb. drum Graphite (G-Plus)

[Graphite applied to a metal fire using scoop or shovel]

Charge 557, 30 lb. pail Sodium Chloride (Super D) – Model B570 & 680

Charge 545, 50 lb. pail Sodium Chloride (Super D) – Model B570 & 680

[Sodium Chloride (Super D) may also be dispensed by a scoop or shovel]

Charge 548, 50 lb. pail Copper (Navy 125S) – Model B571 & 681



ABC DRY CHEMICAL CHARGES

Charge 552, 25 lb. pail

Charge 550, 50 lb. pail

Charge 555, 50 lb. pail – Model B402, IS, VSS

Charge 540, 40 lb. carton

Charge 509, 400 lb. drum



REGULAR DRY CHEMICAL CHARGES

Charge 512, 50 lb. pail

Charge 511, 400 lb. drum

PURPLE K DRY CHEMICAL CHARGES

Charge 553, 25 lb. pail

Charge 515, 50 lb. pail

Charge 517, 400 lb. drum



Wall Hanger Brackets



Bracket Adapters



Vehicle / Marine / Aviation Brackets

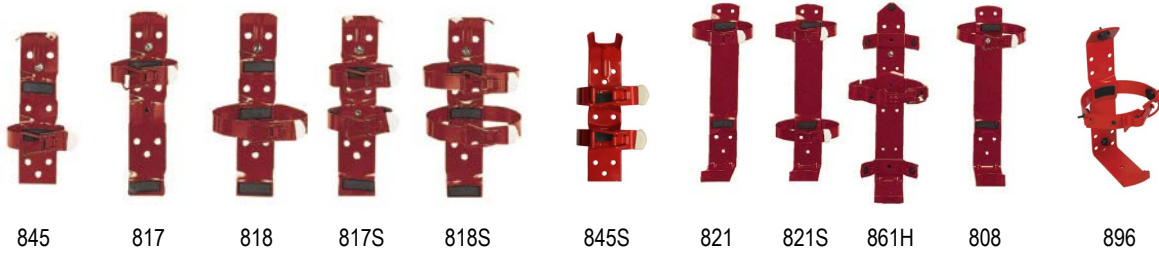

6 & 10 lb. Wall Strap Type

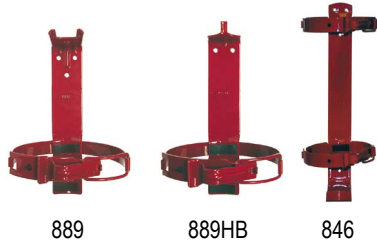

Heavy Duty Box Type Vehicle Brackets
(Red Brackets are Galvanized)

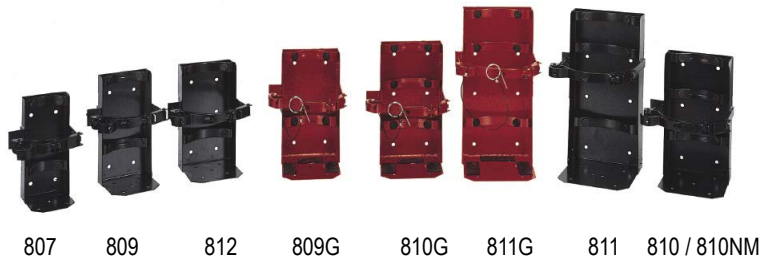

Horn Holder - CO₂
(810 or 811 Bracket)



Heavy Duty Dolly Cart



Heavy Duty Rubber Strap Brackets

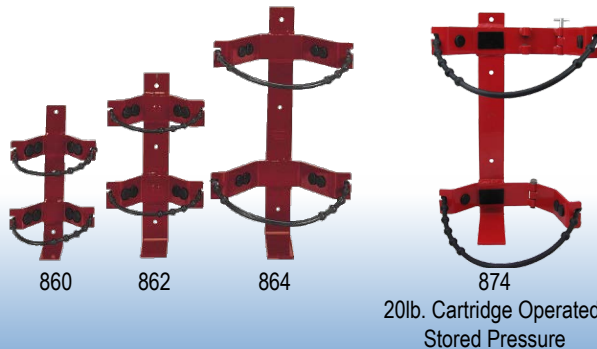

"I" Beam Brackets
Exterior & Interior

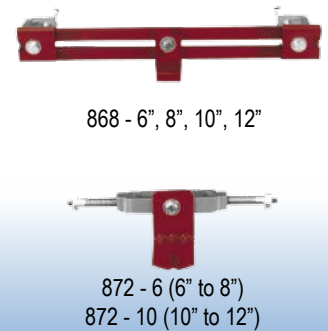

AGENT TYPE	SIZE (CAPACITY)	MODEL	CYL. DIA. (INCH)	INCLUDED BRACKET	USCG BRACKET	OPTIONAL BRACKETS	RUBBER STRAP BRACKETS	859 DOLLY OPTION
WATER	2.5 GAL.	240	7	01007 WALL	N/A	810	864	YES
WATER MIST	1.75 GAL.	B270	7	14315 WALL	N/A	810NM	N/A	
	2.5 GAL.	B272	7	14315 WALL	N/A	810NM	N/A	
AR-AFFF FOAM	6 LITER	254	7	01007 WALL	N/A	810	864	
	2.5 GAL.	250	7	01007 WALL	N/A	810	864	YES
	2.5 GAL.	250CG	7	01007 WALL	810CG	N/A	N/A	
WET CHEMICAL	6 LITER	B260	7	01007 WALL	810	810	N/A	
	2.5 GAL.	B262	7	01007 WALL	810	810	864	YES
	6 LITER	B260CG	7	01007 WALL	810CG	N/A	N/A	
	2.5 GAL.	B262CG	7	01007 WALL	810CG	N/A	N/A	
HALOTRON® I	1.4 LB.	A384T	2.63	845 VEHICLE	N/A	845S	N/A	
	2.5 LB.	B385TS	3	817S AIRCRAFT	N/A	817S	860	
	5 LB.	B386T	4.25	818 V/MARINE	818, 821, 861H	818S, 821, 821S, 807	860	
	5.5 LB.	B394TS	4.25	818S AIRCRAFT	N/A	818S, 821, 821S, 807	860	
	11 LB.	397	6	00575 WALL	812	812	N/A	
	15.5 LB.	398	6	00575 WALL	812	812	N/A	
HALON 1211	1.25 LB.	A344T	2.63	845 VEHICLE	N/A	845S	N/A	
	2.5 LB.	C352TS	3	817S AIRCRAFT	817	N/A	860	
	3 LB.	C354TS	3	817S AIRCRAFT	817	N/A	860	
	5 LB.	B355T	4.25	818 V/MARINE	818, 821, 861H	818S, 821, 821S, 807	860	
	9 LB.	B369	5	00546 WALL	808, 809	808, 809, 846, 889HB, 895	862	
	13 LB.	B371	5	01007 WALL	809	846, 809, 846, 889HB, 895	862	
	17 LB.	361	7	00577 WALL	810	810	864	YES
ABC DRY CHEMICAL	2.5 LB.	B417 / B417T	3	4834 WALL / 817 VM	817	817S	860	
	5 LB.	B402 / B402T	4.25	16591 WALL / 818 VM	818, 821, 861H	818S, 821, 821S, 807	860	
	5 LB.	B500 / B500T	4.25	16591 WALL / 818 VM	818, 821, 861H	818S, 821, 821S, 807	860	
	5 LB.	B424	4.25	16591 WALL	821, 861H	821, 821S, 807	860	
	6 LB.	B443	5	00546 WALL	808, 809, 895	808, 809, 889HB, 895	862	
	6 LB.	B461	5	00546 WALL	808, 809, 895	808, 809, 846, 889, 895	862	
	10 LB.	B456	5	00546 WALL	808, 809, 895	808, 809, 846, 889, 889HB, 895	862	
	10 LB.	B441	5	01007 WALL	809, 895	808, 809, 889HB, 895, 846	862	
	20 LB.	A411	7	00577 WALL	810	810	864	YES
	20 LB.	423	7	00577 WALL	810	810	864	YES
REGULAR DRY CHEMICAL	1 LB.	A620T	2.63	845 VEHICLE	N/A	845S	N/A	
	2.5 LB.	B403 / B403T	3	4834 WALL / 817 VM	817	817S	860	
	5 LB.	B409T	4.25	818 V/MARINE	818, 821, 861H	807, 818S, 821, 821S, 861H	860	
	5.5 LB.	B453	4.25	16591 WALL	818, 821, 861H	807, 818S, 821, 821S, 861H	860	
	6 LB.	B462	5	00546 WALL	808, 809, 895	808, 809, 889HB, 895	862	
	10 LB.	B447	5	01007 WALL	809, 895	808, 809, 846, 889HB, 895	862	
	10 LB.	B457	5	00546 WALL	809, 895	808, 809, 846, 889HB, 895	862	
	20 LB.	A412	7	00577 WALL	810	810	864	YES
	20 LB.	408	7	00577 WALL	810	810	864	YES
	PURPLE K DRY CHEMICAL	2.5 LB.	B410T	3	817 V/MARINE	817	817S	860
5 LB.		B479 / B479T	4.25	16591 WALL / 818 VM	818, 821, 861H	807, 818S, 821, 821S, 861H	860	
10 LB.		B460	5	01007 WALL	809, 895	808, 809, 846, 889HB, 895	862	
20 LB.		A413	7	00577 WALL	810	810	864	YES
CARBON DIOXIDE	2.5 LB.	320	4.38	16591	N/A	896	860	
	2.5 LB.	320NM	4.38	22885	N/A	N/A	N/A	
	5 LB.	322	5.25	00546 WALL	809	809	862	
	5 LB.	322NM	5.25	17737 WALL	N/A	N/A	N/A	
	10 LB.	330	7	00575 WALL	810	810	N/A	
	15 LB.	331	7	00575 WALL	810	810	864	YES
	20 LB.	332	8	22290 WALL	811	811	864	YES
	HIGH PERFORMANCE DRY CHEMICAL FAST FLOW AND COMPLIANCE FLOW	13.2 LB. (6 KG)	594, 592, 595, 599	7	09582 WALL	810 & 810G	810 & 810G	N/A
20 LB. (9 KG)		581, 582, 580, 584, 564, 566	7	09582 WALL	810 & 810G	810 & 810G	864	YES
30 LB. (13.6 KG)		567, 568, 569, 589, 591	8	09581 WALL	811 & 811G	811 & 811G	864	YES
HIGH FLOW EXTINGUISHERS	10 LB.	720, 721, 722	5	01007 WALL	809, 895	808, 809, 889HB, 895, 846	862	
	20 LB.	760, 761, 762	7	00577 WALL	810	810	864	YES
CLASS D DRY POWDER	30 LB.	B570	8	00577 WALL	N/A	811	864	YES
	30 LB.	B571	8	00577 WALL	N/A	811	864	YES

All Amerex brackets meet the latest UL salt spray requirements (240 hrs. @ 20% salt solution - ASTM B117)
1 year manufacturer's warranty applies to all brackets

Wheeled Extinguishers

The largest variety of QUALITY wheeled fire extinguishers available anywhere. See Amerex "Wheeled Fire Extinguishers" brochure for more details.

DRY CHEMICAL STORED PRESSURE



Models 495, 496, 497
50 lb. Dry Chemical



Models 573, 574, 575, 690
HIGH PERFORMANCE
125 / 250 lb. Dry Chemical



Models 488, 489, 490
125/150 lb. Dry Chemical



Models B673, B674, B675
65 lb. / 150 lb.
Halotron™ I

DRY CHEMICAL NITROGEN CYLINDER OPERATED



Models 450, 451, 452, 452OS
125/150 lb. Dry Chemical



Models 467, 468, 469
125/150 lb. Dry Chemical



Models 470, 471, 472
125/150 lb. Dry Chemical



Models 491, 492, 493, 493OS
300/350 lb. Dry Chemical

CLASS D



Model 680R 150 lb.
Sodium Chloride
Model 681 250 lb. Copper

FOAM



Model 630
33 gal. FFFP Foam
Model 325R
32.5 gal. Wet Chemical

CARBON DIOXIDE



Model 333
50 lb. Carbon Dioxide
Model 334
100 lb. Carbon Dioxide

NOVEC™ 1230



Model 775
150 LB. Novec™ 1230

Amerex Fire Suppression Systems



Vehicle Fire Suppression Systems:

Amerex vehicle fire suppression systems are manufactured at our facility in Trussville, Alabama and meet the requirements of the "Buy America Act". Our products are made in the USA so we can provide you with the quality and flexibility your operation demands - when you need it most.



AMGADS IV:

Amerex Mobile Gas Detection System - (4th Generation) gas monitoring system is a pre-engineered system designed to be utilized on any type of alternatively fueled vehicle. The system can be installed by the vehicle OEM or retrofitted. Its advanced technology can detect: Compressed Natural Gas (CNG), Liquefied Natural Gas (LNG), Propane (LPG), Hydrogen and any other hydrocarbon fuel vapors.



SMALL BUS SYSTEM:

The Amerex Small Vehicle System (SMVS) is designed specifically for applications involving front engine vehicles such as Para-Transit, Airport Shuttle buses and other small front engine vehicles. The SMVS kit includes all hardware and components required for a complete turn-key Automatic Fire Suppression System. The electronics portion of the system is made up of a Vehicle Operator Display with Manual Release Push Button, a wiring Interface Module, and two Solid State Heat Detectors. The system is continuously supervised by the system panel which can detect and actuate the system even when the vehicle is not in use.



KP RESTAURANT SYSTEM:

The Amerex KP Restaurant System is a pre-engineered, wet chemical, stored-pressure type with a fixed nozzle agent distribution network. The system is listed by Underwriter's Laboratories, Inc., ULC and tested to U.L. Standard 300. The system shall be designed, installed and maintained in accordance with: Amerex Part No. 20150 "Design, Installation and Maintenance Manual", N.F.P.A. 96, N.F.P.A. 17A, local codes and ordinances by an Authorized Amerex KP Systems Distributor using factory trained personnel.

RESTAURANT SYSTEM:

The Zone Defense Restaurant Fire Suppression System is a pre-engineered, wet chemical, stored-pressure type with a fixed nozzle agent distribution network manufactured by Amerex Corporation. The system is listed by Underwriter's Laboratories, Inc., ULC and tested to UL Standard 300. The system shall be designed, installed and maintained in accordance with: Amerex Part No. 20150 "Design, Installation and Maintenance Manual", N.F.P.A. 96, N.F.P.A. 17A, local codes and ordinances by an Authorized Amerex Zone Defense Systems Distributor using factory trained personnel. The Zone Defense system is fully self-contained and does not require electrical power or connection to either domestic water supply or fire sprinkler supply lines.

The best commercial kitchens are uncompromising when it comes to the quality and reliability of their appliances. At Amerex, we believe the same should be true when it comes to protecting these investments from one of the greatest threats to commercial kitchens - fire. The NEW COBRACommercial Kitchen Fire Suppression System is proof that we do not compromise. There's no other system like it. No other company has it. No commercial kitchen should be without it.



AUTOMATIC INDUSTRIAL DRY CHEMICAL SYSTEM:

The Amerex "IS" system uses our exclusive ABC (Model 555) dry chemical. ABC dry chemical suppresses more fire, by volume, than any other agent, has quick flame "knock-down" and can help to secure Class A fires against re-ignition. Since many hazards involve a variety of fuel sources, our ABC dry chemical, with protection against Class A (wood, paper, pulp), Class B (flammable liquids) and Class C (live electrical equipment) is the agent that is best suited for most Industrial hazards.



SKID SYSTEMS:

Amerex offers a complete line of manual firefighting large capacity skid systems for industrial and extreme hazard environments. Available in Dry Chemical, Foam, and Twin Agent models.



PLEASE SEE INDIVIDUAL SYSTEMS BROCHURES FOR MORE INFORMATION
AVAILABLE TO AUTHORIZED DISTRIBUTORS AND FACTORY TRAINED PERSONNEL



ISO 9001 - Quality
ISO 14001 - Environmental
OHSAS 18001 - Safety
CERTIFIED FIRM

For more information please contact:

Amerex Corporation makes every attempt possible to provide the most current and updated information. Information contained within this brochure is deemed to be as accurate as possible as of the printing date. Routine changes to products, codes and standards, and warranties subsequent to this printing will supersede printed information. Please contact Amerex Corporation for any revisions, updates, or product changes.